

MISCELLANEOUS

Steel Rolling Doors

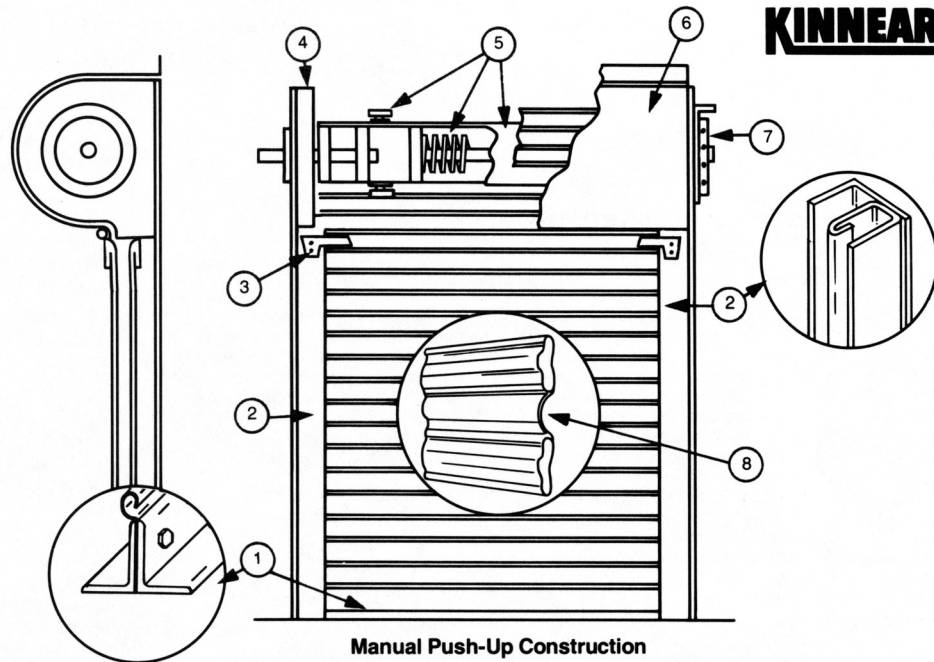

Manual Push-Up Construction

1. Bottom bar, formed of two angles, minimum $\frac{1}{8}$ " thick, and a half slat. Provided to reinforce lower edge of curtain against wind pressure. Angles of equal weight and balance, to hang freely on the curtain to reduce friction and possible binding in the guides.

2. Guides are fabricated from precisely formed angles and channels, designed to guide curtain travel and retain in place under heavy wind pressure.

Note: Designed to withstand 20 psf windload.

3. Groove mouths are specially engineered fittings of cast iron, designed to assure smooth transition of the curtain into guides and act as positive bottom bar stops.

4. Brackets support and enclosed curtain coil and spring barrel at either end.

5. Counterbalance assembly includes spring barrel which serves as load-carrying beam, encases

counterbalance mechanism and provides axis around which curtain coils. (Diameter and thickness limits deflection to 0.03" per lineal foot of span.) If needed, barrel rings are involute shapes of malleable iron to assure proper counterbalance for all points of travel. Oil-tempered, torsion-type counterbalance springs are wound from heat-treated steel, provide accuracy in balancing door. Barrel plugs connect ends of springs to barrel and tension rod. Tension rod of steel shafting holds fixed ends of springs and carries torsional load of spring counterbalance.

Note: The ambidextrous barrel, a Kinnear exclusive, permits changing hand of operation in the field without additional parts. It's a standard feature on most Kinnear service doors.

6. Hood of sheet metal covers curtain coil and counterbalance mechanism.

7. Adjusting wheel is mounted outside bracket on end of tension rod. Simultaneously applies and holds tension on counterbalance springs.

8. Curtain of interlocking slats has windlocks riveted to ends of alternate slats. **Designed to withstand 20 psf windload.**

As originator of the interlocking slat rolling door, Kinnear offers a variety of standard slat sizes and designs in galvanized steel, aluminum and stainless steel. Each is designed to meet certain requirements and all have the following characteristics:

- **Water-shedding assembly**—with reversible design that permits installation which provides a natural water shed on either side.
- **Resiliency**—provided by slats which open and flatten very slightly

when resisting horizontal forces.

- **Free-acting joints**—are interlocking, yet permit easy articulation during coiling.
- **Compressibility**—occurs when interlocking bead telescopes for a cushioning effect as door closes and permits sill adjustment.
- **Appearance**—Shadows and highlights add dimensional eye appeal to enhance overall building decor.

PHONE (785) 827-4491
FAX (785) 827-4494

GRAIN BELT SUPPLY CO., INC.
SALINA, KANSAS

U.S. 1-800-255-2742
1-800-432-8292
1-800-447-0522



MISCELLANEOUS

Steel Rolling Doors KINNEAR®

Most Commonly Used Options

HIGH CYCLE OPERATION can be provided when heavy usage is required. Counterbalance can be designed for (50,000) to (250,000) cycles. Consult factory over 250,000 cycles. Cycle counter furnished standard.

WICKET PASS DOORS can be provided when easy access is necessary without operation of the main door. As an integral part of the rolling door, the pass door is constructed to allow both the door and frame to swing to suit the customer's requirements. All hardware including handles and lock sets are provided standard.

SLOPING BOTTOM BARS are available for most constructions to suit a sloping or irregular sill condition. Construction is of plate and double angle design and is provided in the same material and finish as the curtain. Easily adaptable to bottom weatherseals and safety edges.

MOVABLE AND REMOVABLE POSTS are available for very wide openings where the convenience of the use of more than one door is required. Double grooved post can be designed to be (manually) (mechanically) removed. Posts ordinarily are designed to swing up from the lintel and perpendicular to the opening but can be arranged to slide to the side.

MECHANICAL OPERATION can be provided to suit the customer's requirements. Direct and roller chain drive crank options include awning and gear box operation. Gear drive hoists are available in both single and double gear reduction to suit a 36 lb. hand chain pull. Motor operation can be adapted to suit any specific requirement. Thru wall operation is available on all items.



EXTERIOR MOUNTING options are available for many items. Housings can be provided to enclose and protect from the weather such items as hoists, cranks, motors and thru wall operations.

SPECIAL FINISHES other than standard and depending on material are available on all door parts. All non-galvanized parts are factory primed. Aluminum is not painted. Complete factory prime coat is available. Aluminum material is available with (anodized) or (duranodic) finish. Stainless steel is available with (mill) or (#4) finish. A galvanized finish is available for structural and cast parts. Consult the factory for special finish requirements.

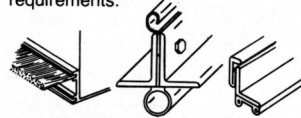

WEATHERSTRIPPING when not provided standard can be furnished on all door constructions except fire doors. **Lintel** weatherstripping of extruded aluminum provided with a brush deal designed to contact the door curtain and prevent the flow of air thru the hood enclosure. **Hood Baffle** of flexible neoprene is all also available to provide direct contact with the coiled slats and is contained inside the hood enclosure. **Guide** weatherstripping of reinforced vinyl can be provided for attachment to either the inside or outside of the guide shape. Reduces drafts and provides quiet smooth operation of the door. Recommended for use with flat slat construction. **Bottom Bar** weatherstripping available in yellow vinyl or extruded shapes and 1/16" neoprene for double angle construction.

FLAT SLATS are available for most constructions when not provided standard. See chart on page 4 for size and gauge limits.

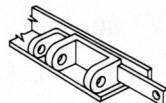

SLIDE BOLT LOCKS can be provided on other than push-up doors, if required.

CYLINDER LOCKS can be provided on the bottom bar for all constructions. Curtain locks are also available for Grille construction. Interlocks are recommended (but not provided standard) for use with motor operated doors—see Electrical extras on pages 20 and 21.

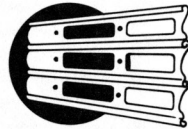

VISION SLATS can be provided when visibility and/or light are required and are designed to be compatible with the variety of slat shapes. Available in panel form or across the full width of the opening. The nominal cutout size of the individual light is 5" wide and 1 1/2" high with a 1" space between lights. Cutout to be backed with 1/16" clear plastic, sealed with a synthetic gasket and retained with a cover plate fastened to the slat.

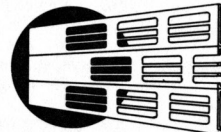

INTERLOCKING SLAT GRILLE CURTAIN is Kinnear's answer to provide the customer with extra protection and still provide air, light and vision of a rolling grille. It is constructed or rib-reinforced, interlocking, extruded aluminum slats approximately 2 1/2" high. Each slat is artistically perforated with slots not exceeding 3 1/2" wide x 1/2" high and 1" space between slots. Offered in clear satin anodized and duranodic finishes only.

SUPPORT TUBES can be provided (3" x 3") for attaching most guide shapes. An excellent application for use with LincArt & VueArt grilles where free standing grille construction is required.

Standard Slat Characteristics

No. 2—Round-faced slat is available in up to 18 gauge steel or B&S aluminum to 14 gauge. Depth of crown: 1/2", 1 3/4" on centers.

No. 4—Round-faced slat for wider doors, available in up to 16 gauge steel or B&S aluminum to 14 gauge. Depth of crown: 7/8", 2 5/8" on centers.

No. 17—Flat-faced slat, offered in up to 20 gauge steel or B&S aluminum to 18 gauge and 0.05" extruded aluminum. Depth of crown: 3/4", 1 5/8" on centers.

No. 14—Flat-faced slat for wider doors, in up to 16 gauge steel or B&S aluminum to 14 gauge. Depth of crown: 3/4", 2 7/16" on centers.

No. 9—Round-faced slat. "The Goliath," designed to provide exceptional strength for large or small openings. Available in roll-formed steel up to 14 gauge or B&S aluminum to 12 gauge. Depth of crown: 1 3/8", 6 1/8" on centers.

Slat Width Limits/Standard Gauges

Heavier gauges available: see slat characteristics above.

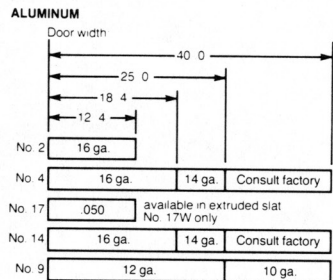
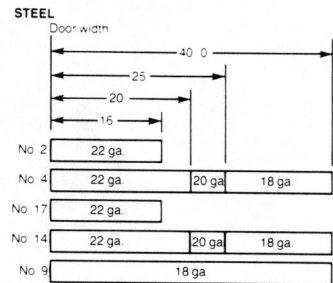

PHONE (785) 827-4491
FAX (785) 827-4494

GRAIN BELT SUPPLY CO., INC.
SALINA, KANSAS

U.S. 1-800-255-2742
1-800-432-8292
1-800-447-0522



MISCELLANEOUS

Power Winch

Turn major jobs into minor chores with easy to operate, compact, lightweight, electric winches.

Without accessories: Single Drum — 37 to 40 lbs.
Double Drum — 68 to 71 lbs.



CHECK (✓) OUT ALL THESE EXTRA-VALUE FEATURES COMMON ADVANTAGES TO BOTH SINGLE AND DOUBLE DRUM:

HI-STRENGTH ALUMINUM GEAR HOUSING—Lightweight-Precision machined to exact specifications.

LIGHTWEIGHT INTERMITTENT REVERSIBLE MOTOR—High speed AC 1.3 HP open universal motor with aluminum body. 115 v-15 amps, 230 v-8 amps.

DOUBLE REDUCTION WORM GEARING—Aluminum bronze worm gears with hardened and ground steel worms. Gear ratios: 533:1 and 267:1.

BALL AND ROLLER BEARINGS—Used throughout for smooth performance.

SINGLE SELECTOR SWITCH CONTROLS (AC ONLY)—Momentary or Maintained available.

SEALED GEARS—Run in oil bath for constant lubrication to help prevent "friction wear" and heat rise.

SIMPLE FIELD REPAIR—Quick disconnect of switch connections and of main box assemblies.

SWITCH BOX MATERIALS—Hi-impact plastic made from permanent mold equipment.

EASY MOUNTING—Mount horizontally, vertically or inversely with the 4-mounting holes below drum. (All positions **except** wall mount with oil filler plug in "up" position.)

DISCONNECT—Available as option on remote controls.

SPECIFICATIONS Single Drum Winches

Series	Drum Cable Layer	Lift Capacity (lbs.)	Line Speed (ft. / min.)		
			In	Out	No Load
1200	1st Full	1200	17	37	28
	Full	700	25	54	41
700	1st Full	700	34	76	56
	Full	400	50	112	82

IMPORTANT 1) First cable layer should have at least the first five wraps **not** in use. 2) Each additional cable layer reduces capacity. Block and Tackle arrangement (use double line only): doubles capacity and cable on drum but reduces line speed by one-half.

SINGLE DRUM WINCH FEATURES:

CABLE LOCK—Lets you attach cable to drum in seconds.

ANTI-STACKING DRUM—Helps eliminate cable "stacking" that can reduce lifting / pulling power.

DOUBLE DRUM WINCH FEATURES:

SPECIALLY GROOVED STEEL DRUMS—Assist in proper alignment for continuous loop cable.

ADDITIONAL BEARINGS—Four large load carrying bearings at drum section.

Double Drum Winches

Series	Drum Cable Layer	Lift Capacity (lbs.)	Line Speed (ft. / min.)	
			Full Load	No Load
1200	Continuous	1200	17	28
700	Continuous	700	34	56

INCLINE DATA: All winches can pull much greater loads than they can lift. (Ex: Series 1200, using first cable layer, can pull 15,200 lbs. running on casters up a 5% grade. This considers a 3% rolling friction.)

Line Speed will vary with voltage input. Figures are based on line voltage at motors (115 v or 230 v).

Hand Winches

1/2 AND 1 TON
WINCHING
CAPACITY

LARGER WINCHES
AVAILABLE.
PLEASE INQUIRE.

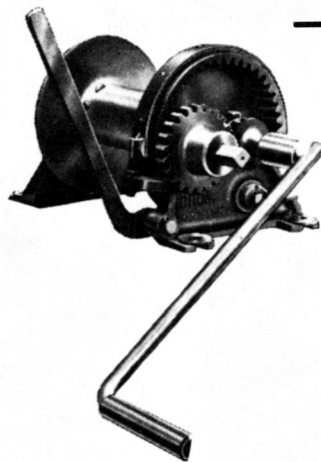

OPTIONS

- 3" OR 6" DRUM
- GEAR COVER
- SAFETY BRAKE HANDLE—HOLDS LOAD AUTOMATICALLY WHEN CRANKING STOPS
- HAND BRAKE—LOWERING TYPE

STANDARD FEATURES

- PORTABLE HAND WINCHES FOR LIGHT LIFTING, LOWERING, HOLDING, MOVING OR SECURING.
- WINCHES ARE CAST STEEL, DUCTILE IRON, BRONZE. AVAILABLE WITH OR WITHOUT HAND BRAKE.
- SPRING OPERATED HOLDING DOGS ARE STANDARD. TWO WAY OPERATION ON MODELS WITHOUT BRAKES, SINGLE DIRECTION ON MODELS WITH BRAKES. TWO DRUM WIDTHS: 3" AND 6".
- MARINE MODELS STANDARD

SPECIFICATIONS

MODEL		CAPACITY 1st LAYER (US TON)	GEAR RATIO	DRUM CAPACITIES								SHIPPING WEIGHT			
W/O BRAKE	WITH BRAKE			1/8 ft	(3) (m)	3/16 ft	(5) (m)	1/4 ft	(6) (m)	5/16 ft	(8) (m)	W/O BRAKE lbs.	W/BRAKE lbs.		
AM3	AM3B	1/2	5.25:1	367	(112)	151	(46)	89	(27)	54	(16)	19 3/4	(9)	22	(10)
AM6	AM6B	1/2	5.25:1	735	(224)	303	(92)	178	(54)	109	(33)	22	(10)	23 1/2	(10.8)
BM3	BM3B	1	5.25:1/10.5:1	367	(112)	151	(46)	89	(27)	54	(16)	22 1/2	(10.2)	24	(10.8)
BM6	BM6B	1	5.25:1/10.5:1	735	(224)	303	(92)	178	(54)	109	(33)	24	(10.8)	27 1/4	(12.3)

PHONE (785) 827-4491
FAX (785) 827-4494

GRAIN BELT SUPPLY CO., INC.
SALINA, KANSAS

U.S. 1-800-255-2742
1-800-432-8292
1-800-447-0522



MISCELLANEOUS

Cable & Accessories

**Fiber Core
6 x 19
Wire Rope**

Dia.	Wt. per Foot	Breaking Strength
3/16"	.059 lb.	3100 lbs.
1/4"	.105 lb.	5480 lbs.
5/16"	.164 lb.	8520 lbs.
3/8"	.236 lb.	12200 lbs.
7/16"	.320 lb.	16540 lbs.
1/2"	.420 lb.	21400 lbs.
9/16"	.530 lb.	27000 lbs.
5/8"	.660 lb.	33400 lbs.
3/4"	.950 lb.	47500 lbs.

**7 x 19
Aircraft Cable**

Dia.	Wt. per Foot	Breaking Strength
3/32"	.017 lb.	1050 lbs.
1/8"	.029 lb.	2000 lbs.
5/32"	.045 lb.	2800 lbs.
3/16"	.065 lb.	4200 lbs.
1/4"	.110 lb.	7000 lbs.
5/16"	.173 lb.	9800 lbs.
3/8"	.243 lb.	14400 lbs.



Eye Slip Hooks
Forged Steel with Large Eye

Size—Inches

- 1/4
- 5/16
- 3/8
- 7/16
- 1/2
- 5/8
- 3/4
- 7/8
- 1

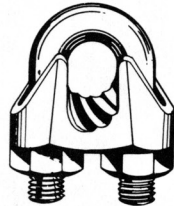

**Malleable
Wire Rope Clips**

Size—Inches

Weight Each	
1/8	.03 lbs.
3/16	.06 lbs.
1/4	.12 lbs.
5/16	.14 lbs.
3/8	.22 lbs.
7/16	.29 lbs.
1/2	.36 lbs.
9/16	.55 lbs.
5/8	.65 lbs.
3/4	.79 lbs.
7/8	1.4 lbs.
1	1.6 lbs.
1-1/8	2.8 lbs.
1-1/4	3.1 lbs.
1-3/8	4.3 lbs.
1-1/2	4.8 lbs.

TURNBUCKLES



Eye and Eye



Jaw and Eye



Hook and Eye



Hook and Hook

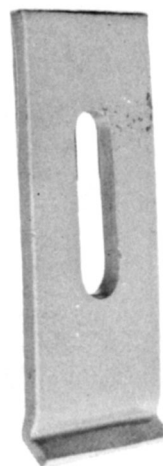

Machinery Clips

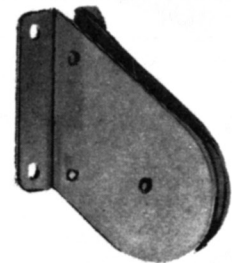

2-1/2" Hot House Pulleys



2-1/2" Side Pulleys



Cast Iron Rope Pulls

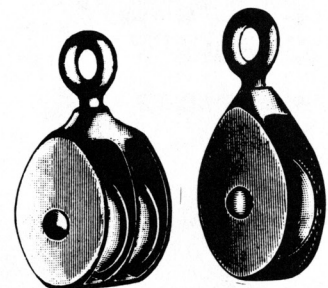

Swivel Eye Awning Pulleys

PHONE (785) 827-4491
FAX (785) 827-4494

GRAIN BELT SUPPLY CO., INC.
SALINA, KANSAS

U.S. 1-800-255-2742
1-800-432-8292
1-800-447-0522



MISCELLANEOUS

LIFT IT - PULL IT - STRETCH IT
with a

Maasdam POW'R-PULL®

Maasdam Pow'r-Pull

- Examples of uses:
 - Closing and opening box car doors
 - Installing conveyor belts
 - Construction and maintenance
 - Moving machinery
 - Erecting chain link fences
- Saves time and man power
- Operates in any position
- No ropes or chains to tangle
- Safety tested
- Drop-forged steel slip hooks
- Special high-strength steel frame
- Cast parts of heat-treated steel
- Special aluminum alloy ratchet wheel
- All steel parts cadmium plated

Model	Capacity	Max. Lift	Cable Dia.	Leverage	Weight	Features
144SB-6	2000#	6 ft.	3/16"	30:1	8#13 oz.	Automatic Let-Down
144S-6	1000#	12 ft.	3/16"	15:1	7#7 oz.	Automatic Let-Down
144D-6	1000#	12 ft.	3/16"	15:1	8#8 oz.	Let-down & Tie-off
108S-6	1000#	9 ft.	3/16"	15:1	7#4 oz.	Automatic Let-down
72S-6	1000#	6 ft.	3/16"	15:1	7#	Automatic Let-down
264S-5	700#	22 ft.	5/32"	15:1	7#10 oz.	Automatic Let-Down
384S-4	500#	32 ft.	1/8"	15:1	7#11 oz.	Automatic Let-down

Replacement Parts

Part #	Item
9000	Handle assembly complete
9100	Frame assembly, less swivel, swivel bodies & cable guide
9700BX	12 ft. 3/16" cable for models 144S-6, 144D-6, or 144SB-6
9701BX	9 ft. 3/16" cable for model 108S-6
9702BX	6 ft. 3/16" cable for model 72S-6
9703BX	32 ft. 1/8" cable for model 384S-4
9704BX	22 ft. 5/32" cable for model 264S-5
7963X	Ratchet wheel
7963A	Socket set screw
7968A	Let-down & lever pawl spring w/screw
7968AX	Let-down & lever pawl spring w/screw
7973	1/4" safety latch hook
7973A	5/16" safety latch hook
7975A	Swivel
7975J	Swivel hook assembly complete (1000# rating)
7975JA	Swivel hook assembly complete (2000# rating)
7976A	Swivel bodies (pair)
7977A	Yoke (clevis)
7978	Cable guide
7980	Swivel body bolt & nut
7981	Cable guide bolt & nut
7985	Cable retainer spring
7986A	Backup lift spring assembly
7987	Ratchet wheel spacer sleeve
7988	Ratchet wheel bolt & nut
8020	Clevis pin
8048	Ratchet wheel guard complete
8049	Snap block

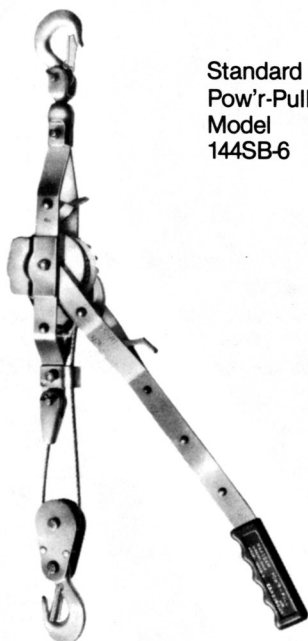

Standard
Pow'r-Pull
Model
144SB-6

PHONE (785) 827-4491
FAX (785) 827-4494

GRAIN BELT SUPPLY CO., INC.
SALINA, KANSAS

U.S. 1-800-255-2742
1-800-432-8292
1-800-447-0522



MISCELLANEOUS

Car Movers

Atlas Car Movers

- #02800 No. VIII Atlas
- #02100 No. X Regular Atlas



Advance Safety Car Wrench

#01600



Rowell Car Movers

- #03100 Samson Single Spur
- #03200 Samson Double Spur
- #03300 Samson Locomotive
- #03400 Rowell Rocker Bearing



Badger Car Movers

- #01500 No. 5 New Badger
- #01910 No. 249 Never Slip, Pearlitic
- #01100 Power King
- #01400 No. 4 New Badger



Handles

- | Code # | |
|--------|-------------------------------------|
| 01020 | Badger, 58" socket type |
| 02020 | Atlas, 54" socket type |
| 03020 | Samson, 58" socket type |
| 03021 | Rowell, 58" socket type |
| 01021 | Badger, 47" socket type |
| 03022 | Samson Loco, channel type (slotted) |
| 01024 | Car wrench |



Safety Handguard

Code #01007. Fits all models.

Spurs

- | Code # | |
|--------|---|
| 01022 | #22 Double spurs for Badger and Atlas Car Movers |
| 01023 | #23 Double spurs for Samson and Rowell Car Movers |
| 01003 | #3 Single spur for Samson Car Movers |

Badger Roller Pry Trucks

- #01704 Size No. 4
- #01705 Size No. 5
- #01706 Size No. 6
- #01707 Size No. 7

Pry trucks available with rubber wheels at same price.

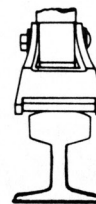

Single Spur



Two-Piece Spur

PHONE (785) 827-4491
FAX (785) 827-4494

GRAIN BELT SUPPLY CO., INC.
SALINA, KANSAS

U.S. 1-800-255-2742
1-800-432-8292
1-800-447-0522



MISCELLANEOUS

Brushes & Brooms

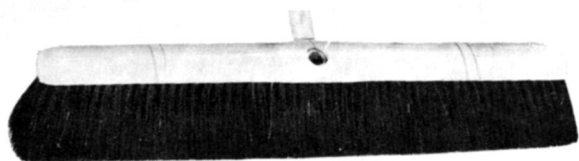

All Tampico Fiber Floor Brush

A sturdy 3" trim brush with 5 ft. threaded handle—wire fastened. An excellent all-purpose low-priced brush for grain elevators and seed houses. 14", 18", or 24".

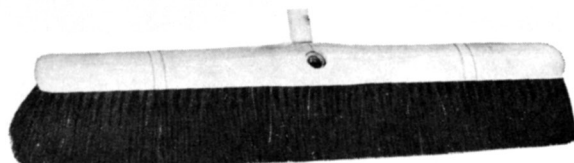

Wire Center Floor Brush

Plenty of spring to readily remove dirt from sticky floors. One row of tempered steel wire. Body of Tampico, horsehair border. 3" trim. Wire set with 60" threaded handle. 16", 18", or 24".

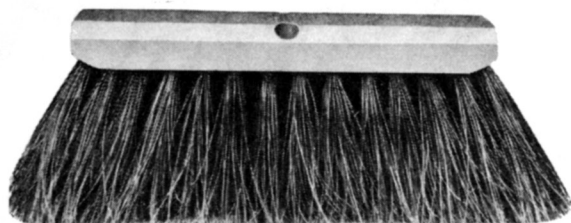

Imported Stiff Bass Fiber Broom

Suitable for sweeping boxcars, mills and elevators. Will outlast most corn brooms. 6-1/4" trim—wire fastened. 14" or 16".

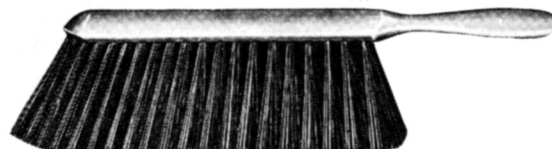

Counter and Bench Brush

Blended imported horsehair. 2-1/2" trim, wire anchored. 8" brush, 14" overall length, or 9" brush, 15" overall length.

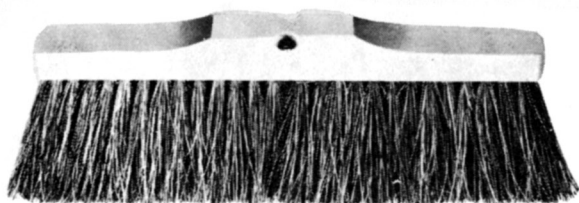

100% Palmyra Garage Brush

For heavy-duty sweeping on rough surfaces. Rugged and long lasting. Wire fastened with sturdy threaded 5 ft. handle. 14", 18", or 24".

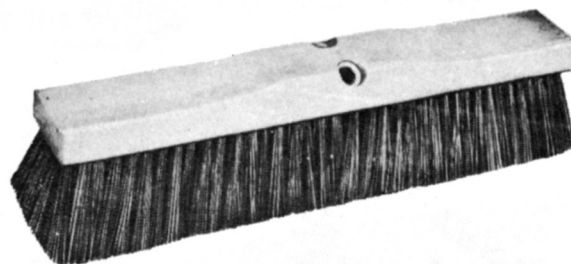

Heavy-Duty Plastic Floor Brush

Can be used wet or dry. Made of 100% brown plastic bristle... will outlast ordinary brushes. Keep away from heat. Includes 60" handle. 14", 16", or 18".

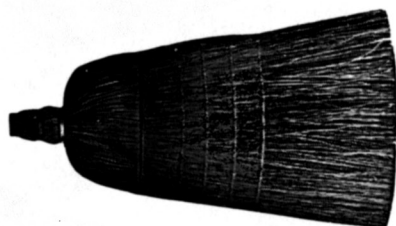

Heavy Duty Broom

Extra heavy corn warehouse broom, especially adapted to sweeping grain. Reinforced by triple stitching and metal band. Balanced hardwood maple handle.

PHONE (785) 827-4491
FAX (785) 827-4494

GRAIN BELT SUPPLY CO., INC.
SALINA, KANSAS

U.S. 1-800-255-2742
1-800-432-8292
1-800-447-0522



MISCELLANEOUS

Mouse Traps

The Original
“KETCH-ALL® ”

The World’s Best Automatic Mousetrap!

- Heavy Duty Industrial Design
- Catches Up To 15 Mice In One Setting
- NO Bait Needed
- NO Dangerous Chemicals or Poisons
- Safe Around Children And Pets
- Continuous Protection Against Mice
- Winds Like An Alarm Clock

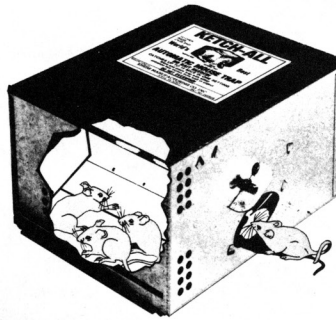

**FASTER EASIER
 CLEANER**

Catches Up To 15 Mice In One Setting!

Easy to use, easy to clean, safe for pets and children.

The Ketch-All uses no bait. Instead, it lures mice because they’re naturally curious creatures. They’ll enter the tunnel opening on either side of the unit merely to investigate. When they do, the Ketch-All is activated and the mouse is safely caught.

“Ketch-All® ” Accessories

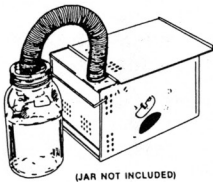

“KETCH-ALL® ”
DROWNING ATTACHMENT
 Helps keep Ketch-All® clean,
 prevents over-catch. Easy disposal.

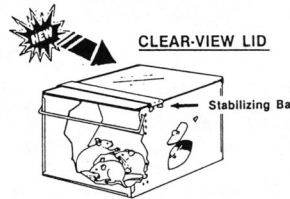

“KETCH-ALL® ”
CLEAR VIEW LIDS
 A quick visual inspection lid to
 view the entire trap.



**Snap-E® Mouse
 Trap**

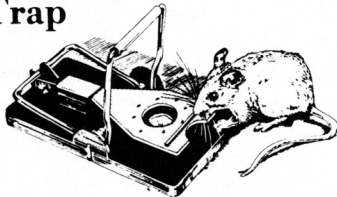

“THE WORLD’S BEST TRAPS”

- 1) **SIMPLE:** the ease of setting the trap is clearly superior.
- 2) **SAFETY:** fingers are never near the snapping end of the trap.
- 3) **SANITARY:** a person never has to touch the rodent to empty and reset the trap.
- 4) **QUALITY:** the durability of polystyrene and steel make Snap-E® very long-lasting.
- 5) **EFFICIENCY:** the unique bait post and large trip paddle means most rodents are caught immediately upon contact.
- 6) **ADVANTAGE:** because consumers clearly see the advantage of purchasing Snap-E® over the wooden variety, it is reusable and WILL NOT poison children or pets.



**Snap-E® Rat
 Trap**

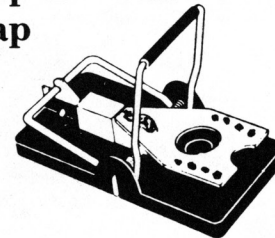

PHONE (785) 827-4491
 FAX (785) 827-4494

GRAIN BELT SUPPLY CO., INC.
 SALINA, KANSAS

U.S. 1-800-255-2742
 1-800-432-8292
 1-800-447-0522



MISCELLANEOUS

Dust Masks & Respirators



Norton Dust Mask with Replaceable Filter

Reduces exposure to low levels of non-toxic nuisance dusts, powders, and pollens. For use by homeowners, schools, and contractors. Does not protect in paint spraying, or against toxic or pneumoconiosis-producing dusts. Filters should be cleaned or replaced when breathing becomes difficult.

Mask: #65310 **Filters: #65312**
(10 per box) (50 per box)



3M Brand 8710 or 8560 Dust/Mist Respirator

For excellent balance of performance and cost, choose the first maintenance-free respirator to be approved. The 8710 is used throughout general industry in a wide variety of applications. Helps protect against coal, cadmium, chromium, lead, cotton dust, silica, and many more.

NIOSH/MSHA APPROVED for dusts and mists with a PEL not less than 0.05 mg/m³.

Recommended for use up to 10X PEL or OSHA standards limitation, whichever is lower.

TC-21C-132

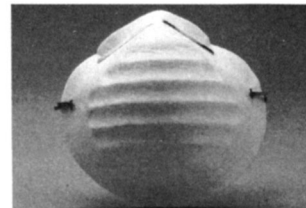

8500 Comfort Mask

THIS MASK WILL NOT PROTECT YOUR LUNGS. IMPROPER USE MAY RESULT IN SICKNESS OR DEATH. IF YOU ARE EXPOSED TO HARMFUL SUBSTANCES, USE A NIOSH CERTIFIED RESPIRATOR.

The 8500 was the innovative first with the self-supporting cup design to provide economy and comfort. It offers relief from the irritating effects of common nuisance dusts such as alfalfa, pollen, animal dander, sawdust, calcium carbonate, gypsum, limestone and many other non-toxic particulates. IT IS NOT NIOSH APPROVED. The 8500 Comfort Mask only offers relief from the irritating effects of non-toxic nuisance dusts.

USING THIS MASK AGAINST ASBESTOS, SILICA, GRAIN DUST, SPRAY PAINTS OR OTHER HARMFUL SUBSTANCES MAY RESULT IN SICKNESS OR DEATH.

DO NOT USE IF THE CONCENTRATION LEVELS ARE ABOVE THE PERMISSIBLE EXPOSURE LIMIT.

THE 8500 IS NOT A RESPIRATOR AND OFFERS NO RESPIRATORY PROTECTION.

PACKAGED:
50/box, 600/case.



Flex-A-Foam Dust Mask

Simplicity and Economy. Only 4 tough, long-wearing interlocking parts with exclusive filters that out-last throw-away types more than 100 to 1. Self-adjusts to any size and shape of face without pressure or discomfort. Weighs just 1 oz. complete.

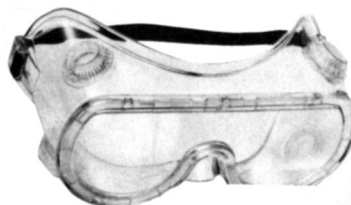

#2022 Monogoggles

Soft vinyl frame with 4 plastic ventilators. Optical quality, distortion-free, plastic lens. Rubber headband. Protects against flying particles, chemical splash, acid and dust conditions. Coverall style permits use with prescription glasses. In accordance with ANSI Standard Z87.1-1968 and U.S. Government specifications.

PHONE (785) 827-4491
FAX (785) 827-4494

GRAIN BELT SUPPLY CO., INC.
SALINA, KANSAS

U.S. 1-800-255-2742
1-800-432-8292
1-800-447-0522



MISCELLANEOUS

Respirators

Comfo® II Respirators

Application

Breathing protection against a variety of hazards can be met with these high-capacity respiratory devices by MSA. The Comfo® II Respirators, which meet the extensive certification requirements of NIOSH/MSHA, utilize chemical cartridges or aerosol filters, or a combination of the two types, to provide the wearer with a wide variety of breathing protection.

Description

Comfo II Respirators feature twin filter cartridges with large area and capacity to provide for low breathing resistance and long service life. Each cartridge is color coded for easy identification as to hazards that particular cartridge protects against.

Comfo II Respirators feature a soft rubber half-mask facepiece with a rolled cushion edge that provides a secure fit on most faces. The facepiece is available in two colors, black and green, and three sizes, small, medium, and large.



Ultra-Twin™ Respirators

Application

Ultra-Twin Respirators provide protection against inhalation of dusts, fumes and mists, radionuclides, gases and vapors, and a combination of particulate and gaseous matter, depending on the cartridges utilized.

Description

The Ultra-Twin Respirator consists of a single-lens facepiece with receptacles for twin cartridges. The facepiece has a large polycarbonate lens that is treated to resist scratching and chemical attack. The facepiece fits close to the wearer's face to provide maximum peripheral vision. The polycarbonate lens has excellent impact resistance.

The facepiece is molded of a soft, black rubber compound which is resistant to facial oils. It is formed with an turned lip around the edge for a comfortable fit and tight seal on a wide variety of facial shapes. Headbands of the same rubber compound are attached to the facepiece by stainless-steel, quick-adjusting roller buckles.

An efficient speaking diaphragm is standard. A baffle molded into the facepiece serves as a deflector for exhaled air to control lens fogging and to direct the voice to the speaking diaphragm.



GMA Chemical Cartridge

GMC Chemical Cartridge

Dustfoe® 66 Respirator

Description

The Dustfoe 66 Respirator is economical. It features a lightweight filter holder designed to eliminate blind spots, and a formable aluminum facepiece that can be shaped to fit individual facial contours. A double headband keeps respirator in place.

Soft-rubber face cushion forms an airtight seal on the face, resists deterioration from facial oils. To prevent accidental removal, exhalation valves are attached by a spring-loaded device and covered by a protective shroud.

All parts can be replaced independently.

Application

The Dustfoe 66 Respirator provides respiratory protection against dusts and mists having a Time Weighted Average not less than 0.05 mg per cubic meter, or 2 million particles per cubic foot.

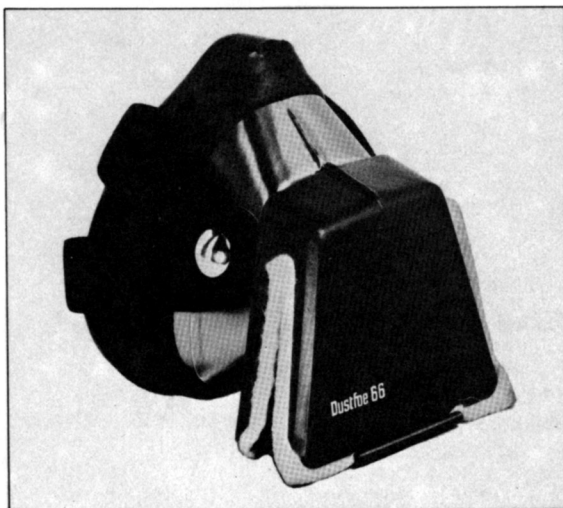

PHONE (785) 827-4491
FAX (785) 827-4494

GRAIN BELT SUPPLY CO., INC.
SALINA, KANSAS

U.S. 1-800-255-2742
1-800-432-8292
1-800-447-0522



MISCELLANEOUS

Measuring Tapes

KESON® LONG FIBERGLASS MEASURING TAPES IN OPEN REEL CASE

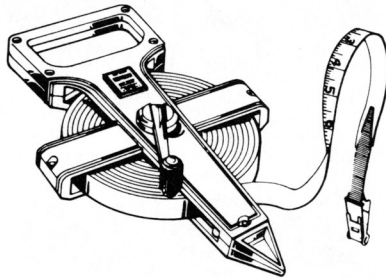

Over 30,000 strands of glass fibers coated with polyvinyl chloride. These Keson tapes are complete with an open reel handle. The special hole in the handle design allows for rapid reeling and unreeling. Allows mud, sand and stone to drop away from case, therefore prolonging the life of the tape blade. The flush folding handle allows for compact storage. Using the unique stake point design you can post and measure alone. All metal case and fiberglass tapes are individually packaged in heavy clear vinyl pouches. Blade is 1/2 inch wide with 2 color markings on snow white background.

Stock No.	Mfr. No.	Length	Price
Graduated in inches and feet			
OTR-18-50		50 Ft	
OTR-18-100		100 Ft	
OTR-18-165		165 Ft.	
OTR-18-200		200 Ft.	
OTR-18-300		300 Ft.	
Graduated in 10ths and 100ths.			
OTR-10-50		50 Ft	
OTR-10-100		100 Ft.	
OTR-10-165		165 Ft.	
OTR-10-200		200 Ft.	
OTR-10-300		300 Ft.	
Graduated in inches one side, metric other side.			
OTR-18M-50		50 Ft	
OTR-18M-100		100 Ft	
OTR-18M-165		165 Ft.	
OTR-18M-200		200 Ft.	
OTR-18M-300		300 Ft.	
Graduated in inches one side, 10ths other side.			
OTR-1810-50		50 Ft.	
OTR-1810-100		100 Ft.	
OTR-1810-165		165 Ft.	
OTR-1810-200		200 Ft.	
OTR-1810-300		300 Ft.	
Graduated in 10ths one side, metric other side.			
OTR-10M-50		50 Ft.	
OTR-10M-100		100 Ft.	
OTR-10M-165		165 Ft.	
OTR-10M-200		200 Ft.	
OTR-10M-300		300 Ft.	

KESON® LONG FIBERGLASS MEASURING TAPES IN METAL CASE

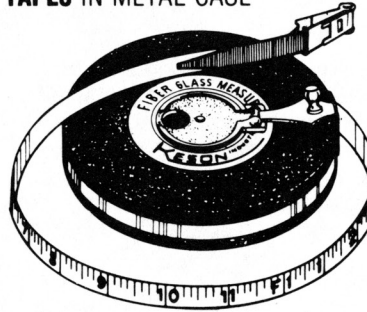

Over 30,000 strands of glass fibers coated with polyvinyl chloride. Engineered for all types of measuring work, the Keson measuring tapes are complete with a lifetime metal case, coated with a protective, rust-inhibitive polyvinyl chloride. The case has double throat rollers and a flush folding handle secured by the push pin handle. All metal parts are heavily plated for added durability. All tapes are one-half inch wide with color fast scale readings permanently legible on a snow white vinyl coated fiberglass.

Stock No.	Mfr. No.	Length	Price
Graduated in inches and feet.			
MC-18-50		50 Ft.	
MC-18-100		100 Ft.	
MC-18-165		165 Ft.	
MC-18-200		200 Ft.	
Graduated in 10ths and 100ths.			
MC-10-50		50 Ft.	
MC-10-100		100 Ft.	
MC-10-165		165 Ft.	
MC-10-200		200 Ft.	
Graduated in inches one side, metric other side.			
MC-18M-50		50 Ft.	
MC-18M-100		100 Ft.	
MC-18M-165		165 Ft.	
MC-18M-200		200 Ft.	
Graduated in inches one side, 10ths other side.			
MC-1810-50		50 Ft.	
MC-1810-100		100 Ft.	
MC-1810-165		165 Ft.	
MC-1810-200		200 Ft.	
Graduated in 10ths one side, metric other side.			
MC-10M-50		50 Ft.	
MC-10M-100		100 Ft.	
MC-10M-165		165 Ft.	
MC-10M-200		200 Ft.	

Refill tapes and replacement cases and reels available.

PHONE (785) 827-4491
FAX (785) 827-4494

GRAIN BELT SUPPLY CO., INC.
SALINA, KANSAS

U.S. 1-800-255-2742
1-800-432-8292
1-800-447-0522



MISCELLANEOUS

Tubular Steel Ladders

Lightweight ... Easy To Handle ... Low Cost

Model A

Has large 6" hooks on both ends. Ideal around elevators, feed and alfalfa mills ... wherever you have the problem of getting in or out of coopered grain cars. The cantilever design not only provides extra strength, but allows ample toe room ... a decided asset to the grain samplers who need both hands free at the grain car. Made from 5/8" steel tubing (not conduit), it's lighter, stronger, and specially braced for a lifetime of use.

Models B & C Cantilever and Standard

Ruggedly braced and reinforced to support heavy loads without slipping, even on ice. Ample toe room.

The Model B cantilever hangs at a convenient work angle. These ladders are constructed of 5/8" steel tubing with 3/4" tubing on hook side for extra strength. You will find uses for these models wherever ladders are needed ... around elevators, mills, farm, home, or industry.



Drop Ladder

Drops and retrieves easily by attached cord which slides the sections up and down as needed. When not in use it fits together in a compact, light-weight unit for easy handling or storing. Will fit into car trunks.

Comes in 3-ft. sections. Add a section in multiples of 3 ft. up to desired length. Rugged tubular steel construction.

Shipping weight: 4-1/2 lbs. per 3-ft. section

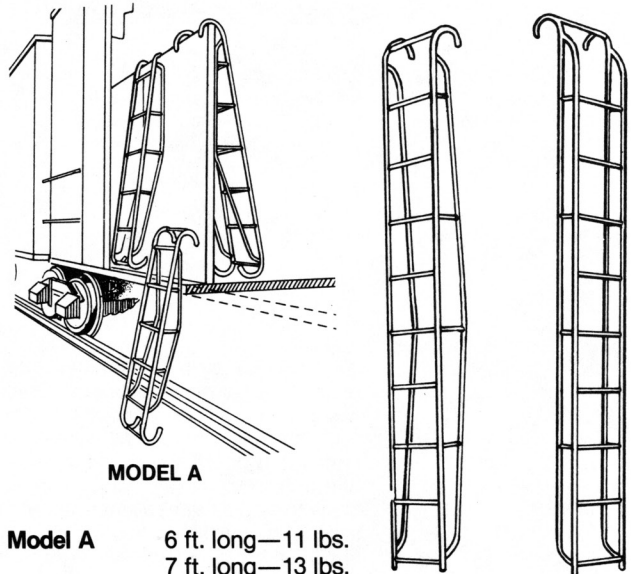

- Model A** 6 ft. long—11 lbs.
7 ft. long—13 lbs.
- Model B** 7 ft. long—12 lbs.
10 ft. long—17 lbs.
12 ft. long—21 lbs.
- Model C** 15 ft. long—27 lbs.
18 ft. long—30 lbs.
20 ft. long—37 lbs.

MODEL B CANTILEVER **MODEL C** STANDARD

Rocker type Safety Feet for Models B & C.

Combination Step-Straight Ladder



These ladders are braced at each step for extra strength and are built for a lifetime of rugged use. Bottoms flared for greater stability.

PHONE (785) 827-4491
FAX (785) 827-4494

GRAIN BELT SUPPLY CO., INC.
SALINA, KANSAS

U.S. 1-800-255-2742
1-800-432-8292
1-800-447-0522



MISCELLANEOUS

Grain Tools

Aluminum Alloy Scoop Shovel

- 10 ga. heat-treated aluminum alloy
- Corrugated, open back bowl
- Split "D" selected ash handle
- Approximately one-half weight of steel scoop
- Spark and acid resistant
- Choice of economy or standard models (economy has lighter ga. blade with #2 handle)
- Blade dimensions:
Size 10 – 14-1/4" x 18"
Size 12 – 14-3/4" x 19"
Size 14 – 15-1/4" x 20"



Fire Extinguishers

DRY CHEMICAL FIRE EXTINGUISHERS ABC

All Units Feature: Heavy Duty Steel Cylinders

- Rugged Metal Valves and Siphon Tubes
- Replaceable Molded Valve Stem Seals •

Exclusive Corrosion and Impact Resistant Epoxy Finish • Pull Pin, Squeeze Grip Operation.



Specifications	ABC				
	2 1/2	5	5	10	20
Size/Type	Nozzle	Nozzle	Hose	Tall Hose	20 Hose
Model Number	417	425	424	441	423
U/L Rating	1A:10	2A:10	2A:10	4A:60	20A:80
Capacity (lbs.)	2 1/2	4 3/4	4 3/4	10	20
Shipping Wt. (lbs.)	5 1/4	8 3/4	9	18 1/2	39
Height	14 1/8"	14 5/8"	14 5/8"	21 1/2"	24"
Width	3 7/8"	5"	8"	9"	10"
Depth (Diam.)	3"	4 1/4"	4 1/4"	5"	7"
Coast Guard App.	Yes	Yes	Yes	Yes	Yes

PHONE (785) 827-4491
FAX (785) 827-4494

GRAIN BELT SUPPLY CO., INC.
SALINA, KANSAS

U.S. 1-800-255-2742
1-800-432-8292
1-800-447-0522



MISCELLANEOUS

Safety Horns

Falcon Super Sonic™



Trigger-Activated
All-Metal Safety Horn

Built for endurance, lasting power and portability, the ultra-strong Super Sonic is now 100% ozone-safe and non-flammable!

- **Durable!** All-metal horns in bright red or deluxe chrome plating.
- **Powerful!** ShriLL, piercing blast can be heard over normal industrial noise.
- **Easy!** Quick trigger operation.
- **Versatile!** Can be used by security guards, hazardous or remote-area workers, heavy duty machinery operators.
- **Long-Lasting!** Replaceable canister delivers hundreds of 2-second blasts

Model #SSCN (Chrome)
Model #SSN (Red)
Refill #SSNR

Falcon
Emergency
Alarm Station

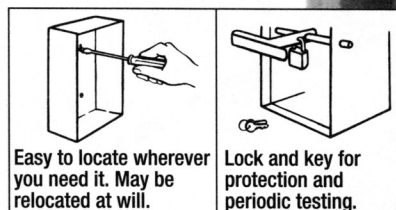
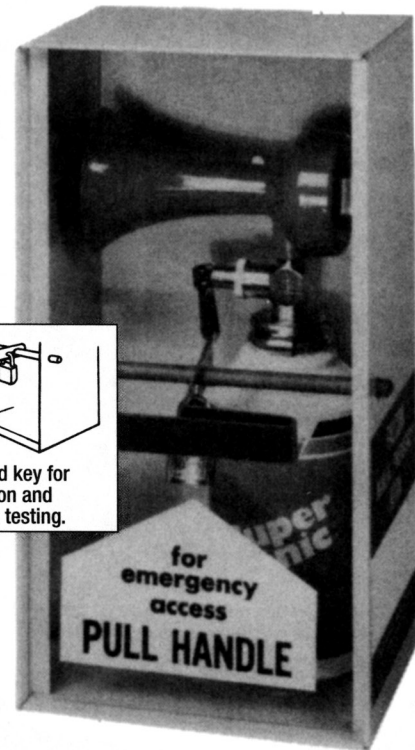

Highly Visible
Safety-Yellow
Wall-Box
System

The 100% ozone-safe, non-flammable Emergency Alarm Station is perfect for low-cost protection – independent of any additional power source!

- **Wall-Mounted!** The 20 gauge safety-yellow steel wall box is easy to locate and relocate wherever you need it! Mounts with just two screws.
- **Tamper-Proof!** Padlock and key system provides protection while permitting periodic testing.
- **Easy!** Emergency handle assures immediate access to horn...activated with the touch of a finger.
- **Powerful!** ShriLL, piercing blast can be heard over normal industrial noise.
- **Versatile!** Can be used for fires, accidents, first aid calls, building evacuations.
- **Replaceable!** Falcon Super Sonic™ replacement canisters readily available.

Model #TAD4N Falcon Emergency Alarm Station
Model #TAB Falcon Emergency Alarm Station (Box Only)
Model #SSNR Falcon Super Sonic Horn Refill
Model #TAR Falcon Emergency Alarm Station Replacement Rods (3/pkg.)

PHONE (785) 827-4491
FAX (785) 827-4494

GRAIN BELT SUPPLY CO., INC.
SALINA, KANSAS

U.S. 1-800-255-2742
1-800-432-8292
1-800-447-0522



MISCELLANEOUS

Cattle Feeders

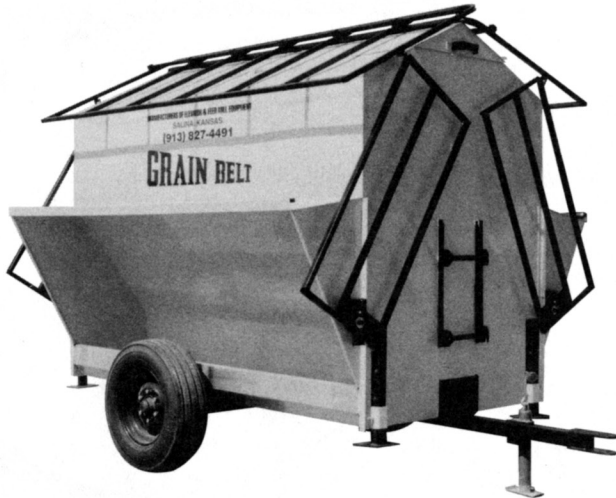

8 Feet



10 Feet



14 Feet

- All welded construction
- 12 ga. galvanized bottom
- 15" ribbed tires
- Adjustable feed gates
- 21" wide feed tray
- Pitched roof
- Leveling stands all 4 corners
- Two 24" wide doors
- Heavy duty ladder
- Heavy duty top wind jack
- No horizontal seams
- Optional fold-up creep attachment

Non-Stock Sizes:

5 Feet (Minimum order 5 units)

12 Feet (Minimum order 3 units)

PHONE (785) 827-4491
FAX (785) 827-4494

GRAIN BELT SUPPLY CO., INC.
SALINA, KANSAS

U.S. 1-800-255-2742
1-800-432-8292
1-800-447-0522





MISCELLANEOUS

Cattle Feeders

Choose the Capacity to Fit Your Operation

Because every cattle operation is managed differently, we can recommend the sizes, capacities and options that best suit your individual operating needs.

- Grain Belt Supply has manufactured quality products for the material handling industry since 1950. We now bring this engineering and manufacturing expertise to a new and complete line of portable cattle feeders.
- We manufacture a quality product produced under strict manufacturing guidelines. Sixteen-gauge painted steel, mig welded for durability and stability. Each feeder is serial numbered for permanent identification purposes.
- Feeders are stocked at our modern fabricating plant in Salina, Kansas for convenient shipment or pick up. All feeders are F.O.B. our plant. We invite your call for price quotations on our free wats line 800-255-2742.

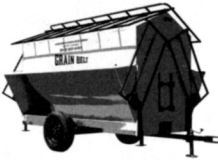
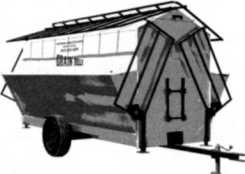
		Size	Bushel Capacity	Ton Capacity	Creep Attachment
Non-Stock Size		5'	80	2.0	optional
		8'	125	3.0	optional
		10'	160	4.0	optional
Non-Stock Size		12'	190	4.75	optional
		14'	220	5.50	optional

PHONE (785) 827-4491
FAX (785) 827-4494

GRAIN BELT SUPPLY CO., INC.
SALINA, KANSAS

U.S. 1-800-255-2742
1-800-432-8292
1-800-447-0522

